

Congratulations on your purchase of a BPM Microsystems device programmer. Your new device programmer was designed to provide years of support for thousands of devices, with the use of optional socket modules. Before you get started, please take the time to carefully read the following instructions that will guide you toward a successful programming operation.

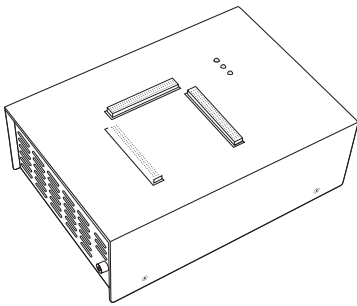

[A] INVENTORY

Check to make sure all items were included in package. For missing items, please contact a BPM Microsystems Customer Service Representative.



Engineering Programmer

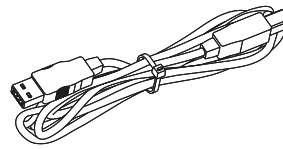

USB Cable

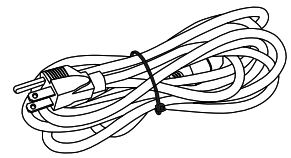

Power Cord

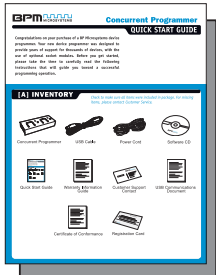

Quick Start Guide

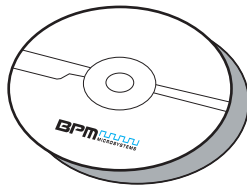

Software CD



Customer Service Representative

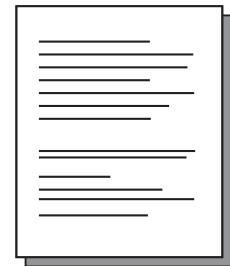

USB Communications Document

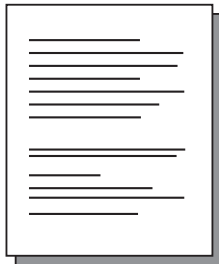

Certificate of Conformance

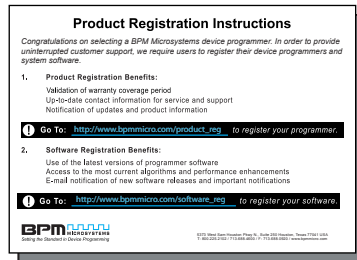

Registration Card

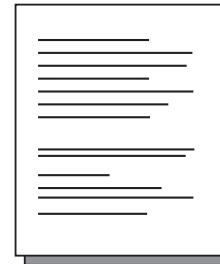

Warranty Information Guide

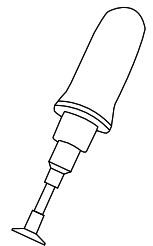

Vacuum Pen

[B] SETUP

1. Place BPWin software CD in the PC CD-ROM drive or download software from www.bpmmicro.com.
-

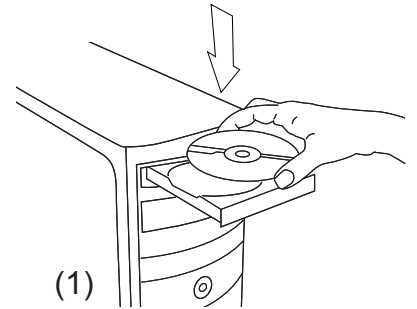

2. Follow on-screen instructions to install BPWin software.
-



3. Restart your PC.
-

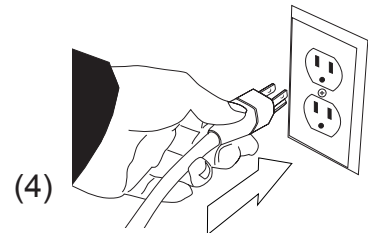

4. Directly connect power cord from programmer to outlet.
-

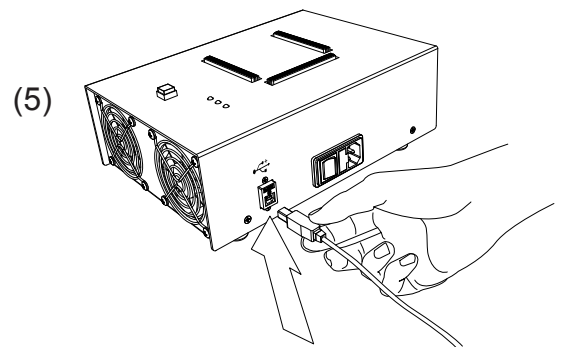

5. Directly connect USB cable to type B USB port on programmer.
-

6. Directly connect USB cable to type A USB port on PC.
(USB 2.0 port recommended for optimal performance.)

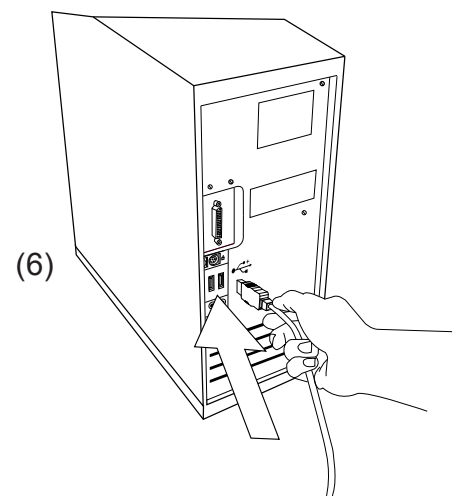

[B] SETUP

7. Insert socket module on the programmer.

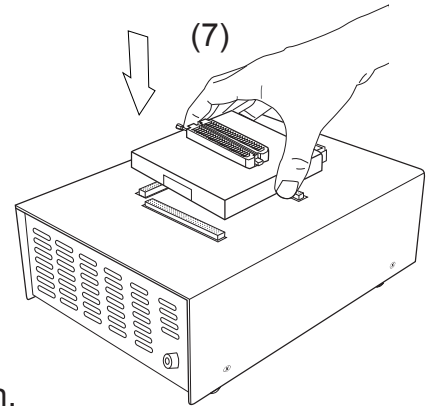

8. Turn programmer on and wait for green pass LED to remain on.

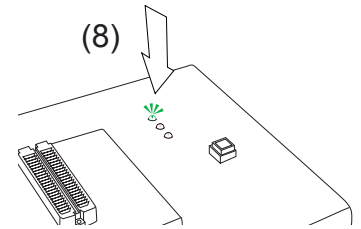

9. Follow on-screen instructions to install USB drivers for the programmer.

10. In the Found New Hardware Wizard Window, Click on **"No, not this time"** selection and Click **Continue**. (Windows XP, Service Pack 2 users only, others proceed to step 11.)



11. Select **"Install software automatically"** and Click **Next**.

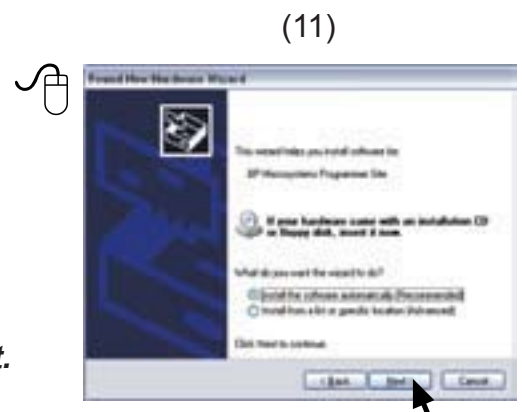

[B] SETUP

12. Refer to on-screen information to verify driver installation

13.  **IMPORTANT!** Once the USB drivers are installed, the PC will recognize that the site is connected at a later time. If a different USB port on the PC is used, the **Found New Hardware Wizard** will launch and install new USB drivers.

14. After Windows has completed the USB driver installation, Click **Finish**.

15. Verify that all USB drivers are loaded correctly, recognized by Windows and attached. The programmer sites will be listed in **Windows Device Manager**. You can open the Device Manager in Windows XP with the Windows+Break keyboard combination. Click the **Hardware** selection. Expand the **BP Microsystems** node. There should be a BP Microsystems programmer site for each programmer site attached and turned on.

(12)



(13)

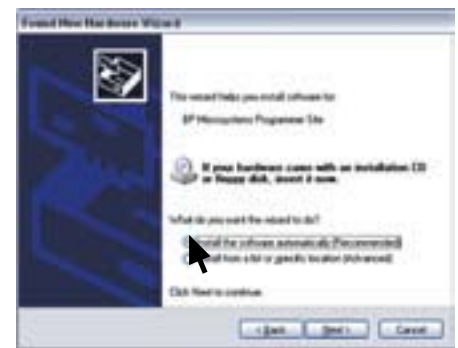

(14)



(15)

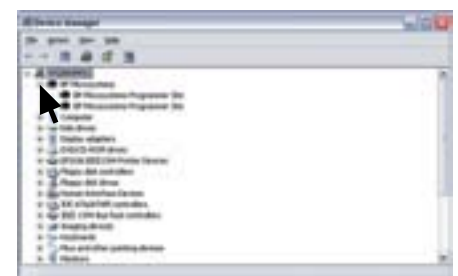

[B] SETUP

16. Launch BPWin software by double-clicking on the BPWin desktop icon or selecting BPWin from the Windows Start menu/Programs list.

17. Check the software screen to make sure the software recognizes the programmer and socket module. Otherwise, you must perform the configure operation (Programmer, port and socket module should appear on the status bar of the BPWin software).

[C] PROGRAMMING A DEVICE

1. Click the **Device** button.

2. Select the device to be programmed.

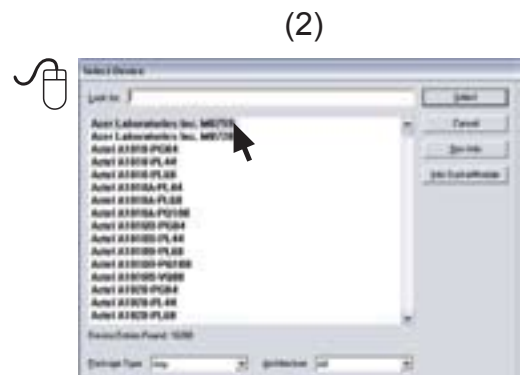

[C] PROGRAMMING A DEVICE

3. Click the **Data Pattern** button.
-



4. Click the **Open** button for file to be loaded.
 - Click the **Browse** button to search for file
 - Select file to be loaded
 - Choose appropriate settings
 - Click **OK**
 - Click **OK**
-

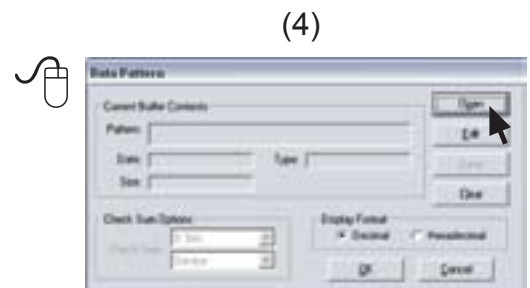

5. Click the **Device Config** button.
(Be aware that some devices may require ranges to be set. Read device notes or contact BPM Microsystems Customer Service with questions.)
-



6. Click **OK** when completed.
-

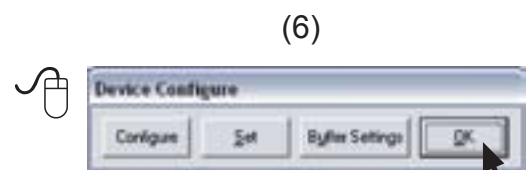

7. Under the **Program tab**, choose appropriate settings for device operations.



[C] PROGRAMMING A DEVICE

8. Select the number of devices to be programmed under the **Quantity** field.
 - a. Place the first device in the socket module.
 - b. Click the **Program** button.
 - c. Press the **Start** button if quantity field is set greater than one (**step c for 1710 only**)

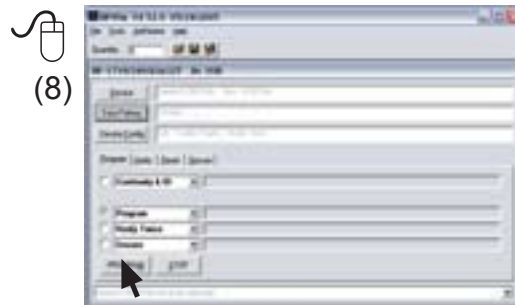

9. Click **OK** to program device.

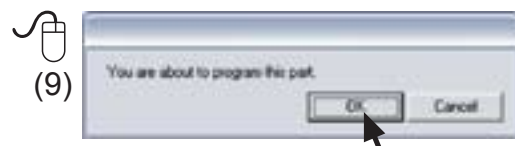

Note: For **1710 Programm**ers, refer to step **10A**.
For **1410/160 Programm**ers, refer to step **10B**.

- 10A.** After the green Pass or red Fail LED is lit, place a device in the socket and press the **Start** button on the programmer.

1710

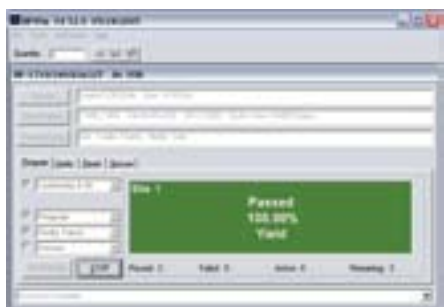

- 10B.** After the green Pass or red Fail LED is lit, place a device in the socket and click **OK**.

1410/1610



[D] PRODUCT REGISTRATION INSTRUCTIONS

1. Product Registration
Go to http://www.bpmmicro.com/product_reg to register your programmer.
2. Software Registration
Go to http://www.bpmmicro.com/software_reg to register your software.